







20 000 706

- diametro foro piletta 32 mm
- rosetta 60 x 60 mm
- con contrassegno caldo



	Dark Chrome	20 000 706-19
	Cromato	20 000 706-00
	Platinato spazzolato	20 000 706-06
	Champagne spazzolato (Oro 22k)	20 000 706-46
	Champagne (Oro 22k)	20 000 706-47
	Dark Platinum spazzolato	20 000 706-99

20 000 706

mm [inches]



Diagramma di portata



Certificati

WRAS_2103001.

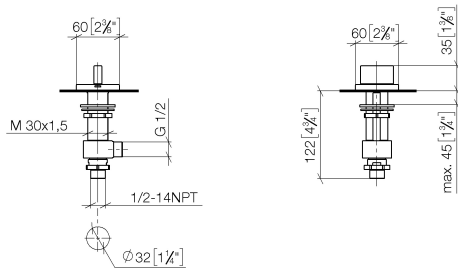
20 000 706

Parts for other finishes can be found here: Cromato

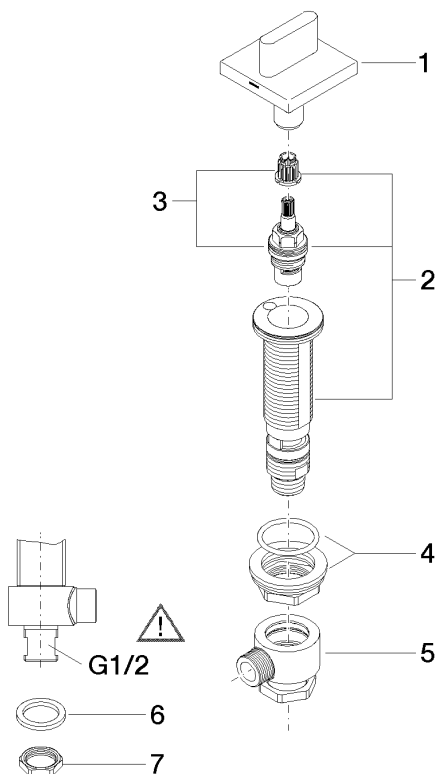

Elenco delle parti di ricambio

N.	Codice articolo	Denominazione	Quantità necessaria	Tempo di produzione
1	90 20 70 051 05-19	manopola (hot)	1	20
2	04 17 11 058 32 90	parte laterale	1	2
3	90 90 03 132 00 90	parte superiore	1	2
4	04 23 10 032 78 90	set di fissaggio	1	2
5	04 17 11 023 10 90	distributore	1	2
6	90 23 30 040 00-19	giunto a vite	1	-
Il pezzo di ricambio non può più essere ordinato, si prega di ordinare l'articolo sostitutivo				
7	09 30 11 059 90	rondella	1	2
8	09 23 10 012 90	dado	1	2